

12 Fiber Mini-Core Cable

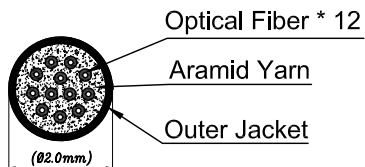

MDC Connector

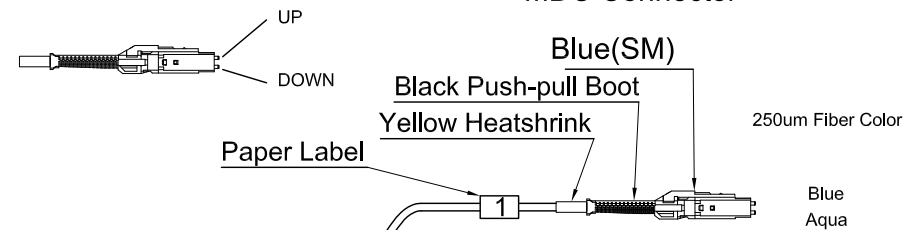

MTP/Female Elite UPC Connector

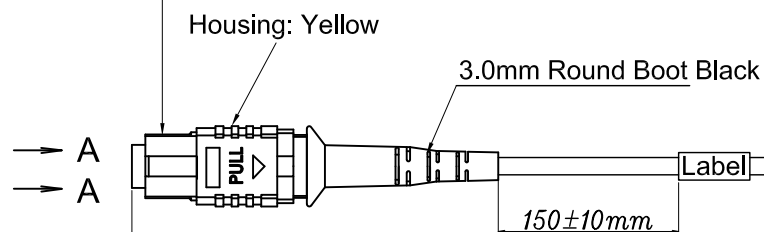

12 Fiber SM 9/125 OS2 Yellow Micro-Core OR Cable

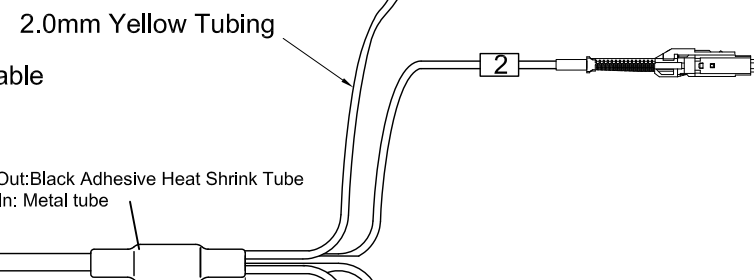

Side A

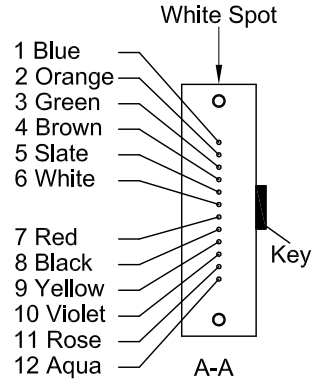
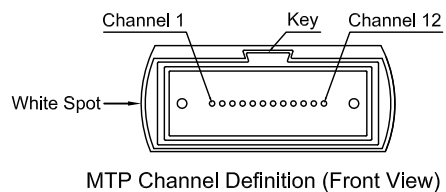

Fiber Chart:

250um Fiber Colors	Side A	Side B	
	MTP	MDC	
Blue	Channel 1	1	UP
Orange	Channel 2	2	UP
Green	Channel 3	3	UP
Brown	Channel 4	4	UP
Slate	Channel 5		
White	Channel 6		Blank
Red	Channel 7		Blank
Black	Channel 8		
Yellow	Channel 9	4	DOWM
Violet	Channel 10	3	DOWM
Rose	Channel 11	2	DOWM
Aqua	Channel 12	1	DOWM

Side B

Specifications:

Type	Single Mode MTP/APC	Single Mode MDC/UPC
Insertion Loss	≤ 0.35dB	≤ 0.3dB
Return Loss	≥ 55dB	≥ 50dB
Test Wavelength	1310&1550nm	

Length Tolerance:

Length (L)	Tolerance
≤ 3M	+150MM/-0
30M ≥ L > 3M	+300MM/-0
> 30M	+1%/-0

Third Angle UNSPECIFIC TOLERANCE LINEAR X.X ±0.1 X.XX ±0.05 X.XXX ± Unit mm Version S2	Drw.	Zhangpeng	2021/12/02	Title 8F SM MTP - MDC Dwg.No. VATG027MTMD0XXXXX
	Chk.	BEN M.	2021/12/02	
	App.	FIGHTER W.	2021/12/02	
	Sheet 1 Of 1			

12 Fiber Mini-Core Cable

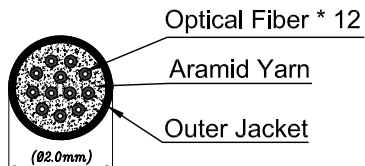

MDC Connector

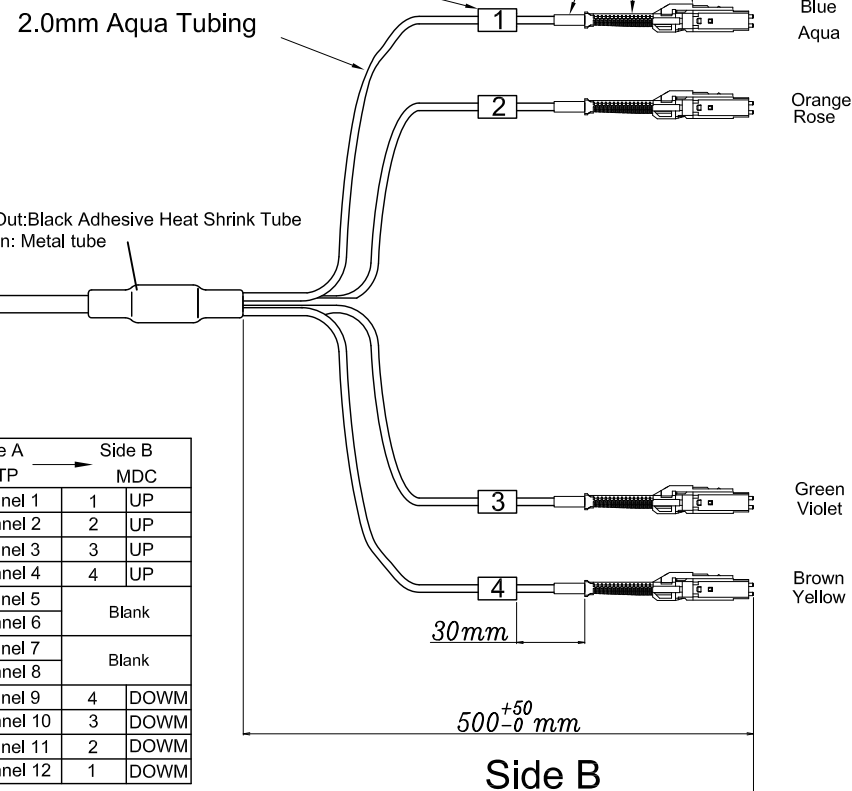
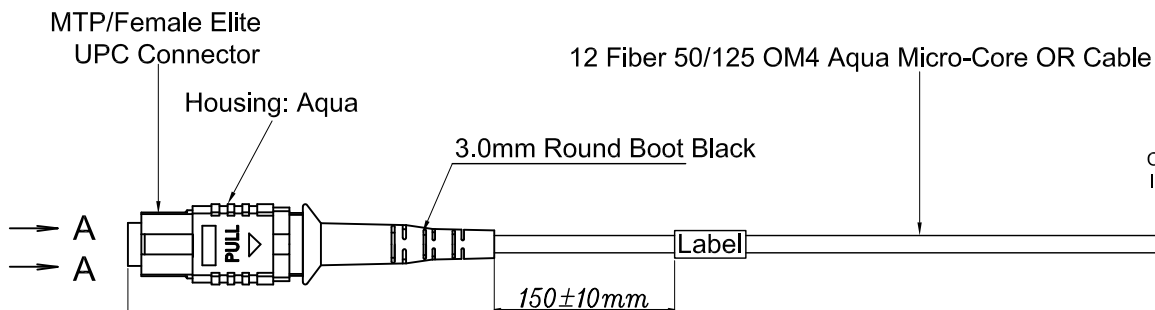
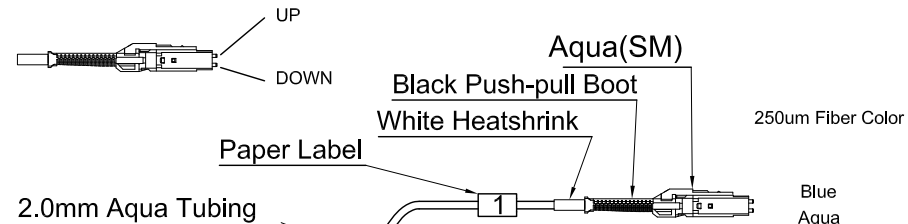

Side A

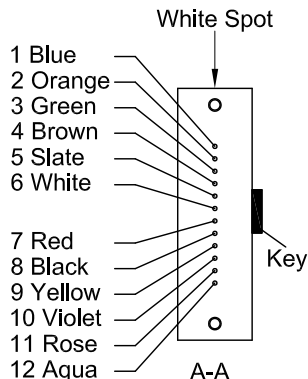
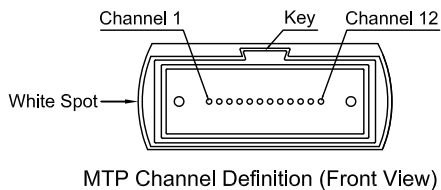

Fiber Chart:

250um Fiber Colors	Side A		Side B	
	MTP	MDC	MTP	MDC
Blue	Channel 1	1	UP	
Orange	Channel 2	2	UP	
Green	Channel 3	3	UP	
Brown	Channel 4	4	UP	
Slate	Channel 5			
White	Channel 6		Blank	
Red	Channel 7		Blank	
Black	Channel 8			
Yellow	Channel 9	4	DOWM	
Violet	Channel 10	3	DOWM	
Rose	Channel 11	2	DOWM	
Aqua	Channel 12	1	DOWM	

L

Specifications:

Type	Multi Mode MTP/UPC	Multi Mode MDC/UPC
Insertion Loss	≤ 0.35dB	≤ 0.3dB
Return Loss	≥ 25dB	≥ 25dB
Test Wavelength	850&1300nm	

Length Tolerance:

Length (L)	Tolerance
≤ 3M	+150MM/-0
30M ≥ L > 3M	+300MM/-0
> 30M	+1%/-0

	Third Angle	Drw.	Zhangpeng	2021/12/02	Title	8F MM MTP - MDC
UNSPECIFIC TOLERANCE		Chk.	BEN M.	2021/12/02		
LINEAR X.X ±0.1 X.XX ±0.05 X.XXX ±	ANGULAR X° ± X° X' ±30' X° X' X" ±15'	App.	FIGHTER W.	2021/12/02	Dwg.No.	VATG028MTMD0XXXXX
Unit	mm	Version		S2		
Sheet 1 Of 1						

12 Fiber Mini-Core Cable

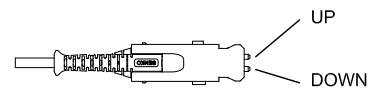
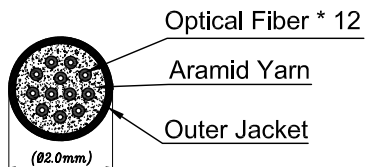

SN Connector, blue

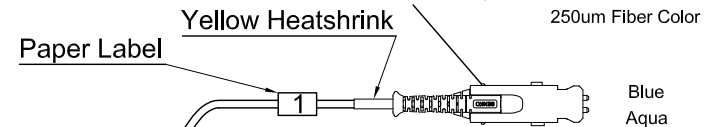

12 Fiber SM 9/125 OS2 Yellow Micro-Core OR Cable

MPO/Female Low loss APC Connector

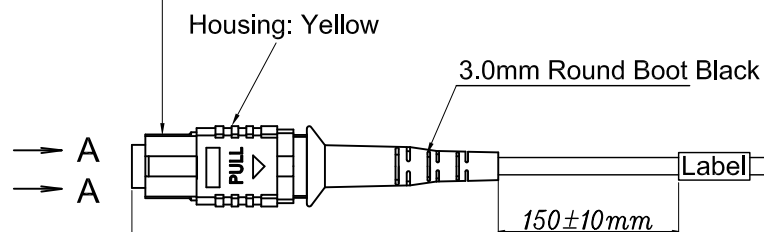

Out: Black Adhesive Heat Shrink Tube
In: Metal tube

Side A

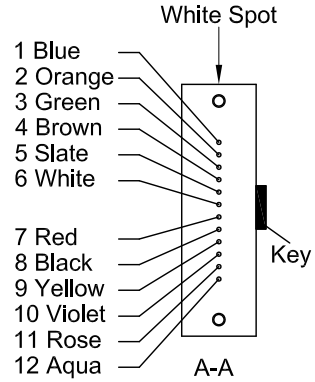
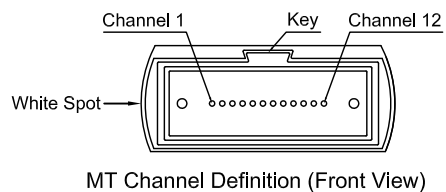

Fiber Chart:

250um Fiber Colors	Side A → Side B	
	MPO	SN
Blue	Channel 1	1 UP
Orange	Channel 2	2 UP
Green	Channel 3	3 UP
Brown	Channel 4	4 UP
Slate	Channel 5	
White	Channel 6	Blank
Red	Channel 7	
Black	Channel 8	Blank
Yellow	Channel 9	4 DOWM
Violet	Channel 10	3 DOWM
Rose	Channel 11	2 DOWM
Aqua	Channel 12	1 DOWM

Side B

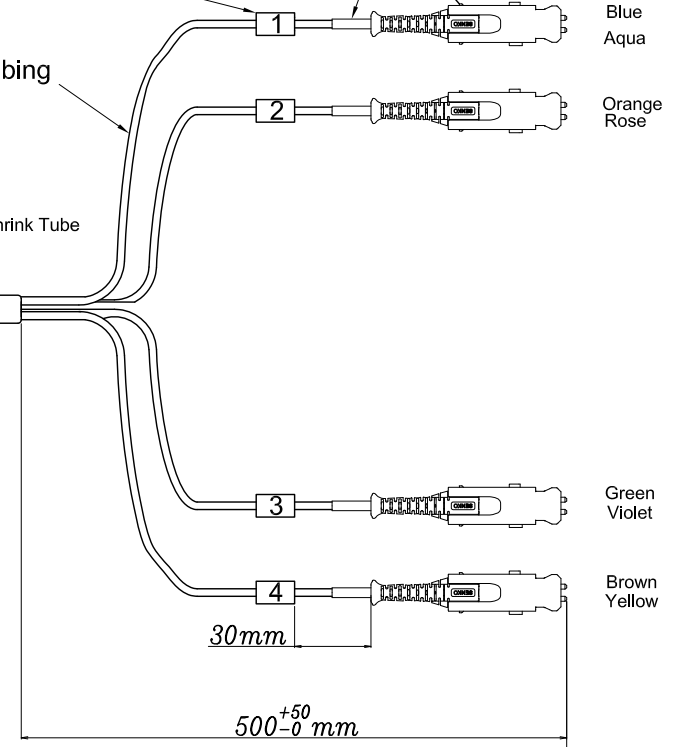

Specifications:

Type	Single Mode MPO/APC	Single Mode SN/UPC
Insertion Loss	≤ 0.35dB	≤ 0.3dB
Return Loss	≥ 55dB	≥ 50dB
Test Wavelength	1310&1550nm	

Length Tolerance:

Length (L)	Tolerance
≤ 3M	+150MM/-0
30M ≥ L > 3M	+300MM/-0
> 30M	+1%/-0

Third Angle UNSPECIFIC TOLERANCE LINEAR X.X ±0.1 X.XX ±0.05 X.XXX ± ANGULAR X° ± X° X' ±30' X° X'X" ±15' Unit mm Version S0	Drw.	Zhangpeng	2021/12/03	Title	8F SM MPO - SN
	Chk.	BEN M.	2021/12/03		
	App.	FIGHTER W.	2021/12/03	Dwg.No.	VATG029MTSN0XXXXX
	Sheet 1 Of 1				

12 Fiber Mini-Core Cable

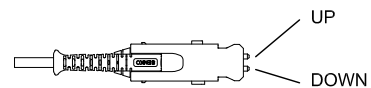
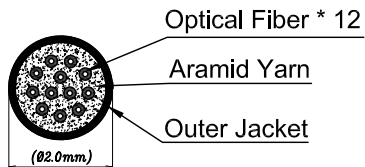

SN Connector

250um Fiber Color

MPO/Female Low loss PC Connector

Housing: Aqua

3.0mm Round Boot Black

12 Fiber 50/125 OM4 Aqua Micro-Core OR Cable

A
A

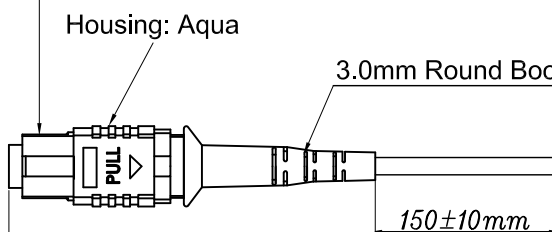

Out: Black Adhesive Heat Shrink Tube
In: Metal tube

2.0mm Aqua Tubing

Paper Label

Side A

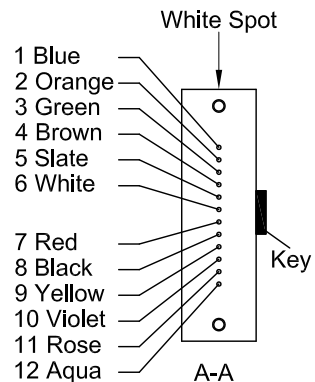
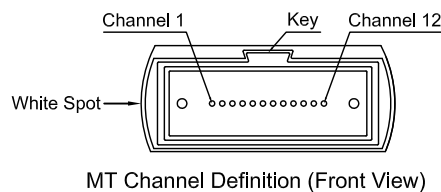

Fiber Chart:

250um Fiber Colors	Side A MPO		Side B SN	
	Channel	Color	Channel	Color
Blue	Channel 1	1	UP	
Orange	Channel 2	2	UP	
Green	Channel 3	3	UP	
Brown	Channel 4	4	UP	
Slate	Channel 5			
White	Channel 6		Blank	
Red	Channel 7		Blank	
Black	Channel 8			
Yellow	Channel 9	4	DOWM	
Violet	Channel 10	3	DOWM	
Rose	Channel 11	2	DOWM	
Aqua	Channel 12	1	DOWM	

30mm

500⁺⁵⁰₋₀ mm

Side B

Specifications:

Type	Multi Mode MPO/PC	Multi Mode SN/PC
Insertion Loss	≤ 0.35dB	≤ 0.3dB
Return Loss	≥ 25dB	≥ 25dB
Test Wavelength	850&1300nm	

Length Tolerance:

Length (L)	Tolerance
≤ 3M	+150MM/-0
30M ≥ L > 3M	+300MM/-0
> 30M	+1%/-0

Third Angle UNSPECIFIC TOLERANCE LINEAR X.X ±0.1 X°.X' ± X°.XX ±0.05 X°.X' ±30' X.XXX ± X°.X'X" ±15' Unit mm Version S0	Drw. Zhangpeng 2021/12/03	Title 8F MM MPO - SN
	Chk. BEN M. 2021/12/03	
App. FIGHTER W. 2021/12/03	Dwg.No. VATG030MTSN0XXXXX	
Sheet 1 Of 1		